



Instructions for Repainting

X-Plus Flush mount



Applicable models: XND-6081FZ, XND-8081FZ,
XND-8081RF, XND-6081RF,
XND-6081F

Contents

Precautions	3
Tools Needed	4
Names of Camera Parts	5
Preparing to paint	6
How to paint.....	9
Assembly.....	12
Completion.....	13

Precautions

This document provides general instructions on repainting Hanwha Vision's X-Plus Flush Mount Cameras. If you want to change their appearance, you should first understand the content of this document.

Please note that Hanwha Vision is not responsible for any problems caused by repainting.



Do not disassembly on your own without reading these instructions. If you do not follow these camera disassembly instructions, your camera could lose its waterproof capability.

Sections where you see any of the following symbols require special attention.



The risk is somewhat higher than usual.



Proper precautions for hazardous chemicals must be taken when working.











Important

If there is a 'Important' notation, apply additional caution when working.

Tools Needed

Prepare the tools needed for your work, referring to the table and images below.

Table of tools needed

Tool name	Image	Tool name	Image
Paper		Phillips screwdriver	
Pen or pencil		Protective goggles	
Masking tape		Cleaning cloth	
Scissors		Protective gloves	
Star wrench (TORX)		Dust mask	

<Fig. 1. Table of tools>

Names of Camera Parts

The names of each part of the camera are as shown below.

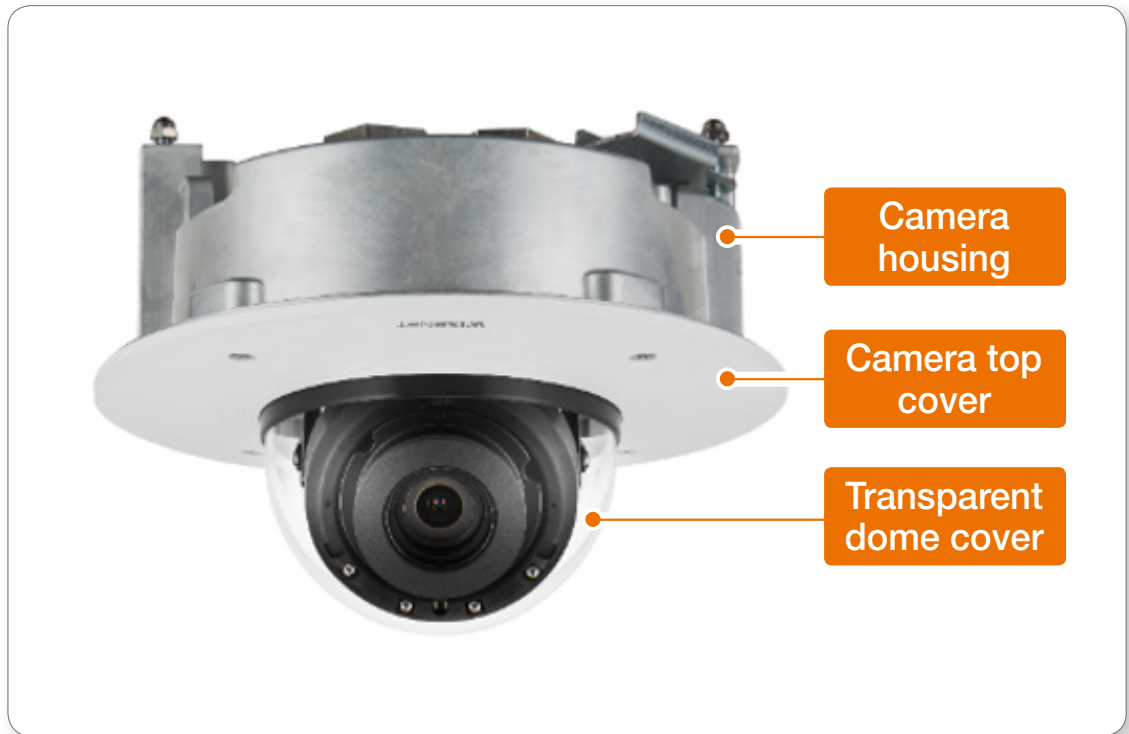

<Fig. 2. Names of Camera Parts>

Preparing to paint

Disassembly

1. Disassembling the camera top cover

- ✓ With your 4mm star wrench (TORX), unscrew the four screws in the top cover by turning them counterclockwise so that you can remove the cover.

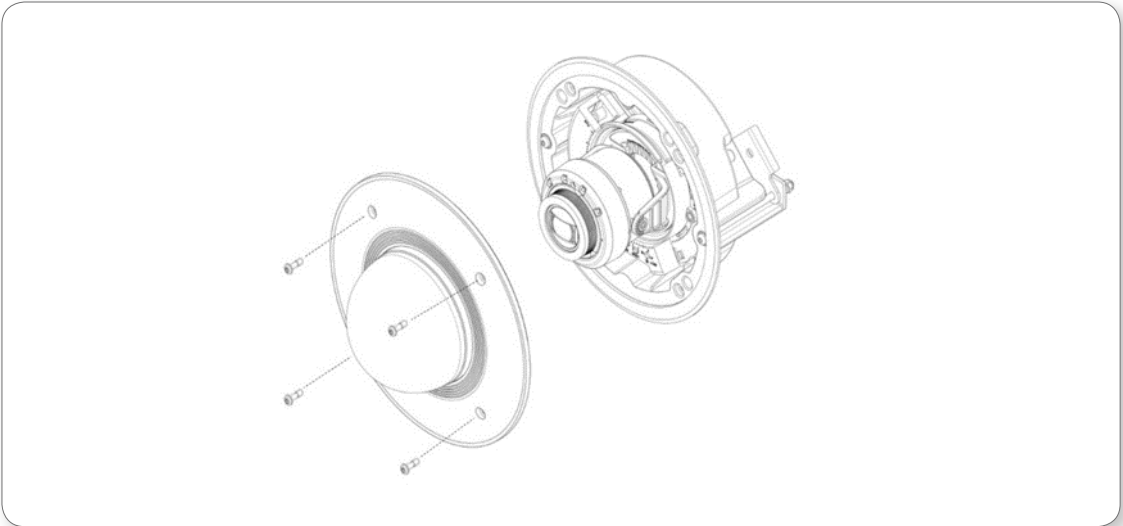

<Fig. 3. Top cover disassembled>

2. Disassembling the transparent dome cover

- ✓ With your Phillips (+) screwdriver, unscrew the three screws inside the cover by turning them counterclockwise so that you can remove the transparent dome cover.

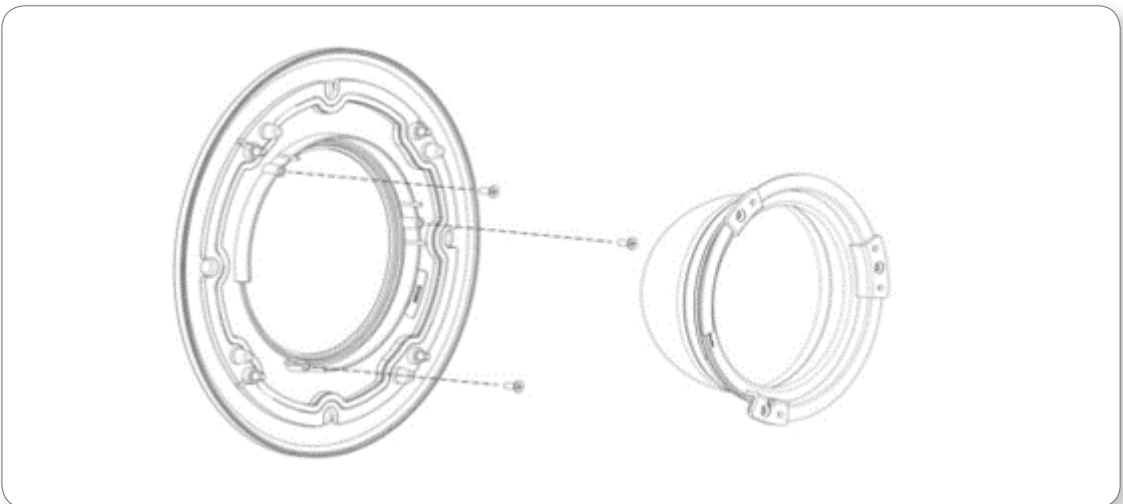

<Fig. 4. Transparent dome disassembled>

Preparing to paint

Cautions

3. Caution after disassembly

Be careful not to let moisture or water come into contact with the PCB part after disassembly. Touching or shocking the lens module part may adversely affect the performance.

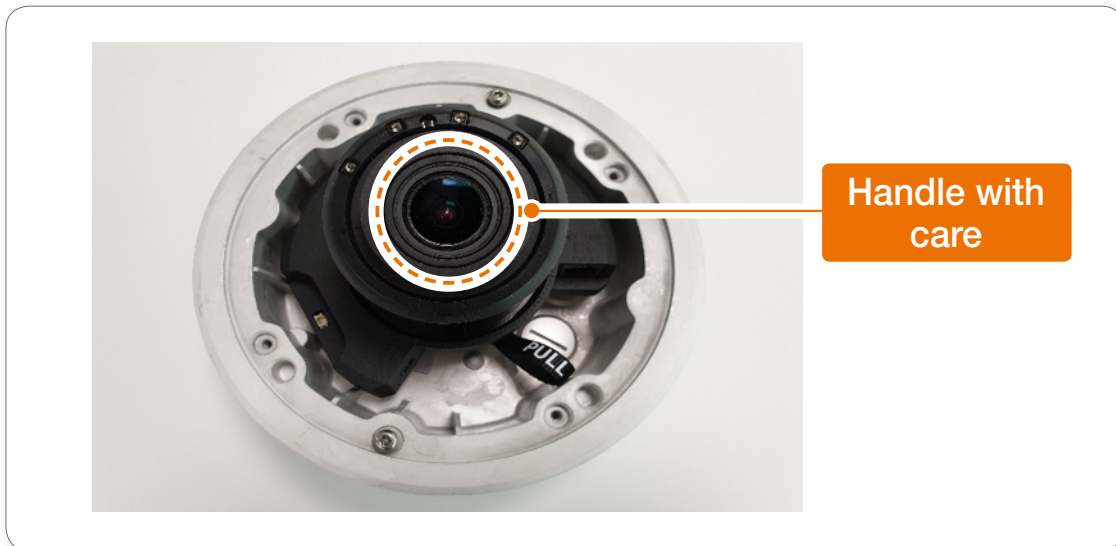

<Fig. 5. Management of disassembled parts>

4. The brand logo will be covered when you paint.

※ Please note that separate logo stickers are not provided.

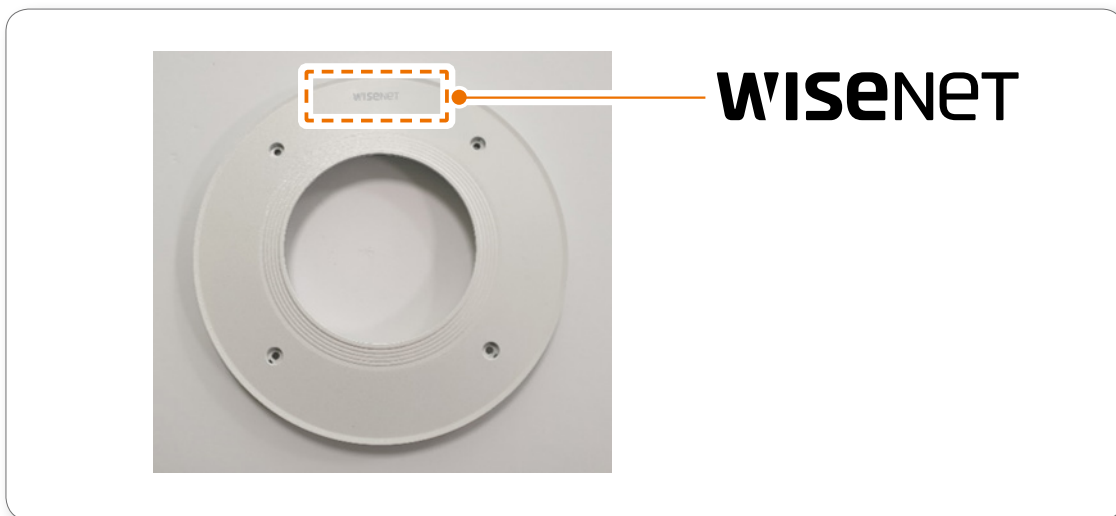

<Fig. 6. Top cover disassembled>

Preparing to paint

Masking

1. Mask the inner side of the dome cover using a masking tape so that paint does not intrude the inner surface.



<Fig. 7. Top cover masked>

2. If paint gets to the inner ceiling of the front cover, it may adversely affect the waterproof capability of the cover. Therefore, it needs to be masked completely.



<Fig. 8. Ceiling masked>

How to paint



It is recommended to use a professional painting company with all the necessary equipment and tools.



Paints most appropriate for the materials should be used for all painting applications. Paint can cause irritation to the skin or respiratory system because it contains harmful substances. It should never be swallowed.

Be careful not to let the paint touch your eyes or skin. Wear suitable protective clothing, gloves, and face shield.



For painting, you should choose a clean, well-ventilated place.

Painting

1. In the case of metal surfaces, paint with primer first for better paint adhesion. If your new paint color is brighter than the current color, a white primer is recommended.



<Fig. 9. Primer painted>

How to paint

2. Paint it once and wait until it is completely dried. Then, paint it once more (Two times recommended).



<Fig. 10. First painting>

3. After the surface is painted for the first time and dried, paint it again.



<Fig. 11. Second painting>

Drying

1. After finishing the painting, completely dry the surface for better paint adhesion. Use a drying chamber to dry it, or let it dry naturally.



<Fig. 12. Drying chamber>

2. When paint is completely dry, remove the masking tape attached to the skin cover.



<Fig. 13. Masking tape removed>

Assembly

1. Assemble the transparent dome cover and then wipe off any fingerprints and dust inside the dome with a cleaning cloth. Any foreign substances remaining in there may affect the video quality.



<Fig. 14. Dome cover cleaned>

2. Use a star wrench (TORX) to join the top cover to the bottom.

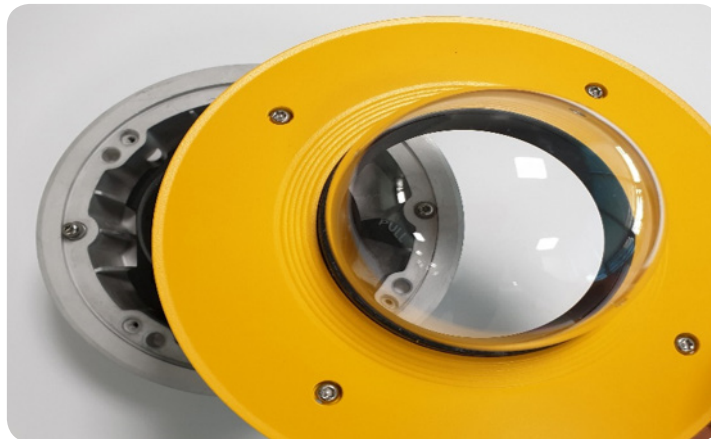

<Fig. 15. Assembling the top cover>

Completion

The image of repainting complete.



<Fig. 16. Repainting complete>

Head Office

6, Pangyo-ro 319 beon-gil, Bundang-gu, Seongnam-si,
Gyeonggi-do, 463-400 Rep. of KOREA
Tel : +82.70.7147.8753 Fax : +82.31.8018.3740
www.hanwhavision.com

Hanwha Vision America

500 Frank W. Burr Blvd. Suite 43 Teaneck, NJ 07666
Toll Free +1.877.213.1222 Direct +1.201.325.6920
Fax +1.201.373.0124
www.hanwhavisionamerica.com

Hanwha Vision Europe

Heriot House, Heriot Road, Chertsey, Surrey, KT16 9DT, United Kingdom
Tel +44.1372.235663 Fax +44.1932.57.8101
www.hanwhavision.eu

Hanwha Vision Vietnam Hanoi Office

28th Floor, Handico Building, Pham Hung Street, Me Tri ward,
Nam Tu Liem District, Hanoi City, Vietnam
Tel : +84.91.982.40.88
<http://hanwhavision.com>
